



Rasmussen

THE GAS LOG COMPANY

12028 E. Philadelphia St. Whittier, CA 90601 U.S.A (562) 696-8718 FAX (562) 698-3510
E-Mail: gaslogs@riwinc.com Web http://www.riwinc.com

TR 3000 SERIES

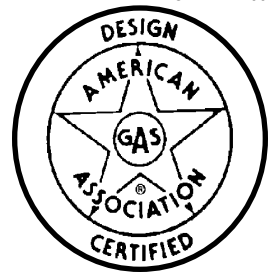

FORM TR-499

Triple Burner Decorative Gas Log Appliance

Assembly, Installation, and Operation Instructions for
Rasmussen Triple Burner Decorative Gas Appliance Models:

18" Match Lighted	(PA, PR, MA, NA, XF, WSA, LS,UA)(18)/(XF, LS)(21)/(PA, MA, NA, WSA,UA)(24Z)-TR18-J-(N)
18" Manual Pilot Control	(PA, PR, MA, NA, XF, WSA, LS,UA)(18)/(XF, LS)(21)/(PA, MA, NA, WSA,UA)(24Z)-TR18-M-(N,P)
18" Switch Pilot Control	(PA, PR, MA, NA, XF, WSA, LS,UA)(18)/(XF, LS)(21)/(PA, MA, NA, WSA,UA)(24Z)-TR18-S-(N,P)
24" Match Lighted	(PA, PR, MA, NA, XF, WSA, LS,UA)(24)-TR24-J-(N)
24" Manual Pilot Control	(PA, PR, MA, NA, XF, WSA, LS,UA)(24)-TR24-M-(N,P)
24" Switch Pilot Control	(PA, PR, MA, NA, XF, WSA, LS,UA)(24)-TR24-S-(N,P)
30" Match Lighted	(PA, PR, MA, NA, XF, WSA, LS,UA)-(36)-TR30-J-(N)
30" Manual Pilot Control	(PA, PR, MA, NA, XF, WSA, LS,UA)-(36)-TR30-M-(N,P)
30" Switch Pilot Control	(PA, PR, MA, NA, XF, WSA, LS,UA)-(36)-TR30-S-(N,P)

WARNING: If you do not follow these instructions exactly, a fire or explosion may result causing property damage, personal injury or loss of life.

Read these Instructions carefully and retain them for future use.

- THESE APPLIANCES ARE CERTIFIED TO THE FOLLOWING STANDARDS:**
- TR-18; TR-24; TR-30-(M) Manual or (S) Switch: Vented Decorative Appliance ANSI Z21.60/CGA 2.26-M96
 - TR-18; TR-24; TR-30-(J) Match Lit: AGA 7-94 (Natural Gas Only)

WARNING: Improper installation, alteration, service or maintenance can cause injury or property damage. Read these instructions thoroughly before installation. For assistance or additional information, consult your gas log dealer, qualified installer, service agency or gas supplier.

FOR YOUR SAFETY
Do not store or use gasoline or other flammable vapors and liquids in the vicinity of this or any other appliance.

- FOR YOUR SAFETY**
- WHAT TO DO IF YOU SMELL GAS**
- Do not try to light any appliance.
 - Do not touch any electrical switch; do not use any phone in your building.
 - Immediately call your gas supplier from a neighbors phone. Follow the gas suppliers instructions.
 - If you cannot reach your gas supplier, call the fire department.

IMPORTANT INFORMATION

1. This gas log set must be installed only in a solid-fuel burning fireplace with a working flue and constructed of non combustible material. **The flue must exhaust all products of combustion.**
2. The minimum permanent free opening of the fireplace chimney or chimney damper must be at least (*Square Inches - see **ITEM 5** below) based on a minimum chimney height of at least 10 feet. The area of the flue must not be less than 1/10 the area of the fireplace opening.
3. Solid fuels shall not be burned in a fireplace where a decorative appliance is installed.
4. The chimney damper must be fixed in a manner to maintain permanent free opening as outlined in item 2 above at all times. To accomplish this, install the damper clamp (provided) on the edge of the damper blade to prevent its closing or drill a hole or holes in the damper.
5. The minimum size (in inches) of the fireplace in which the log set is to be installed must be as follows:

LOG SIZE	BURNER SIZE	HEIGHT	DEPTH	WIDTH	* MINIMUM CHIMNEY OPENING
18 or 21	18 INCH	18	14	30	39 SQ IN
24 or 27	24 INCH	18	14	36	51 SQ IN
30 or 36	30 INCH	18	14	42	64 SQ IN

6. A fire place screen must be in place when the log set is in operation and, unless other provisions for combustion air are provided, the screen shall have opening(s) for introduction of combustion air. Glass doors are not certified with the Log Set. However, if used, Glass Doors must be wide open when the burner is on to allow air for safe combustion and venting.
7. The minimum inlet gas supply pressure for the purpose of input adjustment shall be 6 inches of water column on natural gas and 11 inches of water column on LP gases.
8. The maximum inlet gas supply pressure shall be 7 inches of water column on natural gas and 14 inches of water column on LP gases.
9. The installation and the provision for combustion and ventilation air must conform with the National Fuel Gas Code ANSI Z223.1 - Latest Edition.
10. The gas log set and its individual shutoff valve must be disconnected from the gas supply piping system during any pressure testing of that system at test pressures in excess of 1/2 psig (3.5 kPa). The gas log set must be isolated from the gas supply piping system by closing its individual manual shutoff valve during any pressure testing of the gas supply piping system at test pressures equal to or less than 1/2 psig (3.5 kPa).
11. The area around the gas log set must be clear and free from combustible materials, gasoline and any other flammable vapors and liquids.
12. Do not use this appliance if any part has been under water. Immediately call a qualified service technician to inspect the appliance and to replace any part of the control system and any gas control which has been under water.

WARNING: CARBON MONOXIDE POISONING MAY LEAD TO DEATH

When used without fresh air, gas log set may give off carbon monoxide, an odorless, colorless, poisonous gas.

Some people, pregnant women, persons with heart or lung disease, anemia, or under the influence of alcohol and persons at high altitudes are more affected by carbon monoxide than others.

Early signs of carbon monoxide poisoning resemble the flu: Headache, dizziness, and/or nausea. If you have these signs, the gas log may not be installed or working properly, or the chimney flue may be blocked. **GET FRESH AIR AT ONCE!** Have gas log set and chimney flue serviced before using again.

DAMPER MUST BE WIDE OPEN WHILE BURNING

OPEN A WINDOW AN INCH OR TWO FOR FRESH AIR WHEN USING YOUR GAS LOG

WARNING! CHECK FOR PROPER VENTING

A properly sized, unobstructed chimney will normally vent all fumes and products of combustion. Any odor or smoke detected inside the room is an indication that the flue is not properly removing the combustion products. **SHUT OFF THE BURNER IMMEDIATELY! THE CAUSE OF THE VENTING PROBLEM MUST BE DISCOVERED AND CORRECTED BEFORE CONTINUED USE OF THE GAS LOG SET.** Continued use with improper venting may cause damage to your fireplace, room and furnishings and could cause serious illness. If improper venting is suspected, **immediately have log set and chimney flue serviced.**

Periodically examine and clean the venting system. Once a year, a qualified agency should examine and clean the venting system of your solid fuel burning fireplace.

ATTENTION

THIS LOG SET IS FOR USE ONLY WITH THE GAS TYPE INDICATED ON THE RATING PLATE. READ INSTRUCTIONS CAREFULLY BEFORE ASSEMBLY

ASSEMBLY AND INSTALLATION:

REQUIRED TOOLS AND MATERIALS:

Screw Driver, Adjustable Wrench, Pipe Wrench, Pipe Sealing Compound, Matches.

PREPARATION:

1. This Gas Log set must be **INSTALLED IN A FULLY VENTED METAL OR MASONRY FIREPLACE WITH A WORKING FLUE THAT IS SAFE FOR BURNING A WOOD FIRE.** The Flue **MUST BE FREE OF ANY OBSTRUCTIONS.**
2. Turn off gas supply to fireplace.
3. Clean fireplace floor of any ashes.
4. Attach damper clamp over edge of fireplace damper blade as shown. When installed properly, damper clamp prevents accidental full closure of damper. **See FIGURE 1.** If unable to install provided damper clamp, consult **IMPORTANT INFORMATION** on front page of these directions.

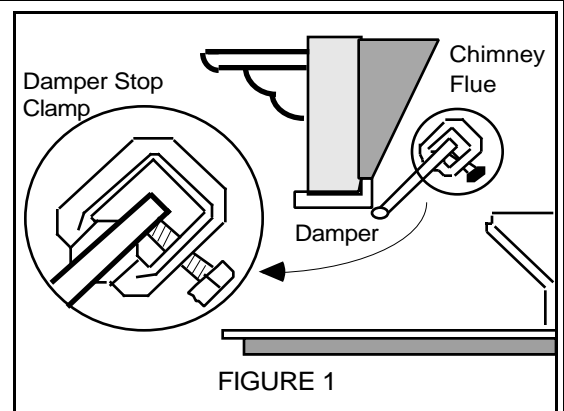

INSTALLING BURNER/GRATE:

1. Place grate/pan/control assembly inside firebox towards the back of the fireplace. Center grate left to right.
2. Connect log set to gas supply line. (Do not use pipe compound on flared connections.)
3. Turn on the gas valve at the supply line in the fireplace. Check connections for gas leaks by using a soapy solution. **DO NOT USE OPEN FLAME.**
4. Completely fill **REAR BURNER** and **MIDDLE BURNER** with **Sand (Natural Gas) or Volcanic Ash (Propane Gas)** ensuring that burner(s) are completely covered with sand. Completely cover both **FRONT BURNER TRAY** burners with **Sand or Volcanic Ash** (as supplied with your log set.) Sprinkle a light covering of **MIXED EMBER MATERIAL** (vermiculite and ember fiber) over **Sand or Volcanic Ash**. (Figure 2).

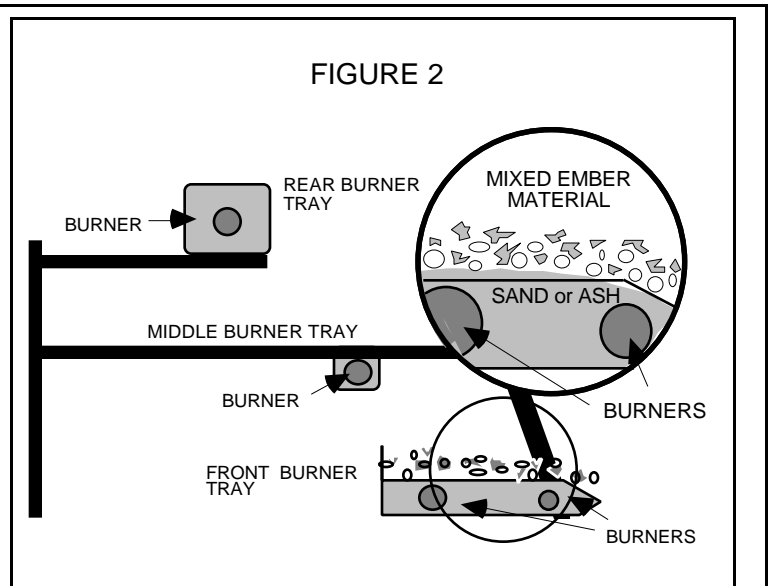

NOTE: Pulling apart **Ember Fibers** into many very small pieces will increase the glowing ember effect.

LOG LOCATION:

1. Place the **FRONT LOG** (the largest log) and **REAR LOG** (next largest log) on grate as shown.

2. Place **TOP LOGS** and **PINE CONE** (if provided) as shown.

NOTE: To reduce soot formation on logs, place **TOP LOGS** on log stack as shown to minimize direct contact with burner flames.

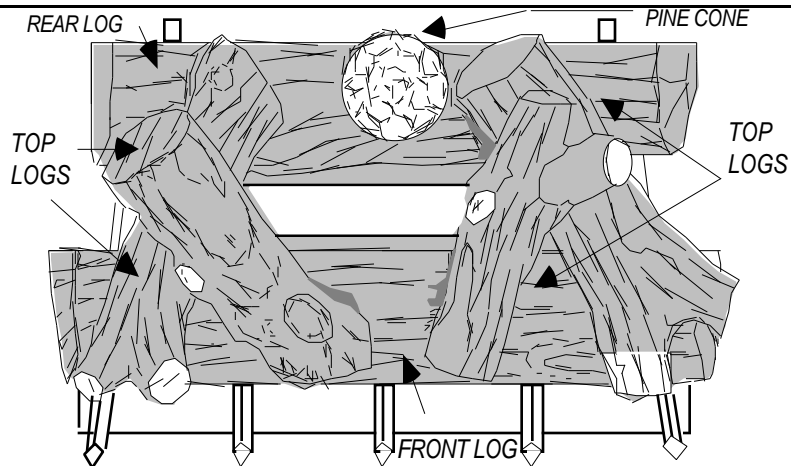

LIGHTING INSTRUCTIONS:

IMPORTANT! CHIMNEY DAMPER MUST BE WIDE OPEN

FIGURE 3

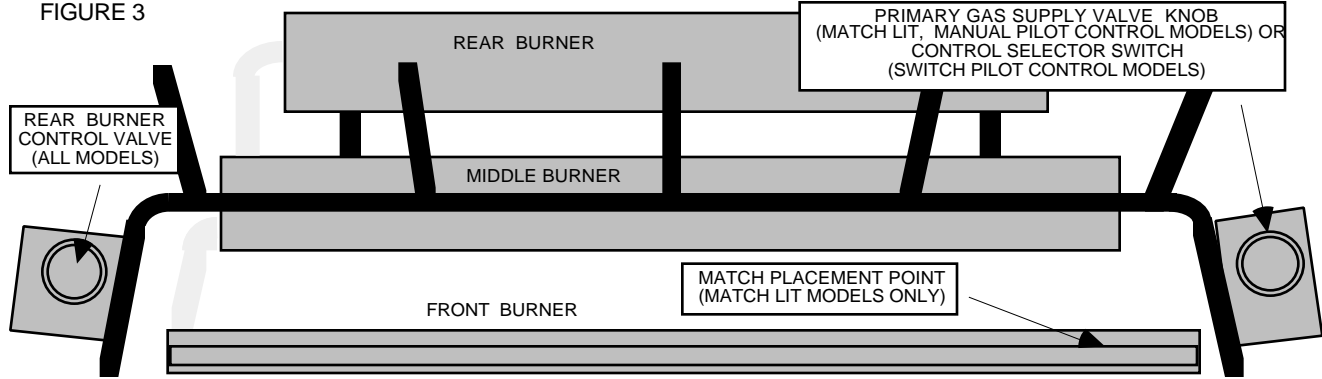

TR-18; 24; 30-(J) (MATCH LIT) (NATURAL GAS ONLY):

This appliance must be lighted by hand each time it is used. When lighting the appliance, follow these instructions exactly. Use only your hand to push in or turn the gas control knob. Never use tools. If the knob will not push in or turn by hand, don't try to repair it, call a qualified service technician. Force or attempted repair may result in a fire or explosion.

1. Place lighted match on right side of **FRONT BURNER TRAY** near inlet end of burner (**FIGURE 3**). **DO NOT HOLD MATCH IN HAND!**
2. Slowly open **PRIMARY GAS SUPPLY VALVE** and wait for burner to light. (**FIGURE 3**)
3. Adjust **PRIMARY GAS SUPPLY VALVE** to obtain desired flame height. Ensure adequate gas supply is available to operate **FRONT BURNER TRAY** and **MIDDLE BURNER TRAY**.

TR-18; 24; 30-M-(MANUAL PILOT CONTROL)

PILOT LIGHTING AND OPERATION:

1. Slightly push in **PRIMARY GAS SUPPLY VALVE** knob and turn to "SEASON/OFF" see (**FIGURES 3 & 4**).
2. Wait five minutes before lighting.
3. Slightly push knob and turn to "PILOT/OFF".
4. Depress valve knob until air is bled and gas flows to pilot. Press **PIEZZO IGNITOR BUTTON** (**FIGURE 4**) to light pilot. Continue to hold valve knob in until Pilot remains lit when knob is released.
5. Slowly turn **PRIMARY GAS SUPPLY VALVE** knob to "ON". All three burner's (**FRONT BURNER**, **MIDDLE BURNER** and **REAR BURNER**) flame height is controlled by the position of the **PRIMARY GAS SUPPLY VALVE** knob.
6. If the appliance fails to light or if pilot goes out, repeat steps 1 through 5 above .
7. For complete shutdown, slightly push **PRIMARY GAS SUPPLY VALVE** (**FIGURE 4**) knob in and turn to "SEASON/OFF".

FIGURE 4

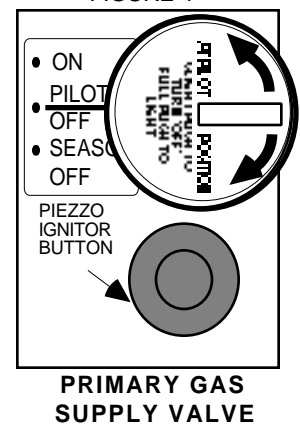

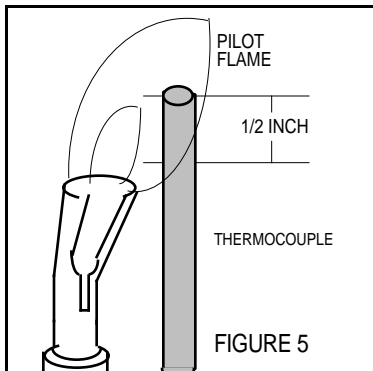

PILOT FLAME ADJUSTMENT (TR-18; 24; 30-M-(MANUAL PILOT CONTROL):

PILOT ADJUSTMENT:

1. Pilot flame should be steady and soft blue surrounding approximately 1/2 inch of the thermocouple tip. (Figure 5)
2. If adjustment is necessary, use a narrow long stem screw driver to turn **PILOT ADJUSTMENT SCREW** (Figure 6).

PILOT ADJUST SCREW. (FIGURE 6) Turn clockwise for less flame, counter clockwise for more flame.

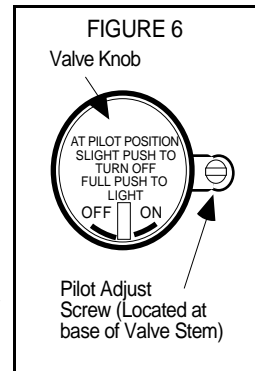

TR-18; 24; 30-S-(SWITCH PILOT CONTROL)

LIGHTING PILOT:

1. Slightly push **MILLIVOLT GAS VALVE** Knob. Turn clockwise to "OFF". (FIGURE 7)
2. Put the **CONTROL SELECTOR SWITCH** into the **OFF** position. (FIGURE 7) Accessory Controls must also be turned "OFF". For Remote Control, put the **Remote Receiver Switch** in the "OFF" position. For **Thermostat Controlled** models, turn temperature dial to "OFF" or to the lowest temperature setting.
3. Wait at least five minutes to allow gas which may have accumulated around burner to escape.
4. Slightly push **MILLIVOLT GAS VALVE** Knob and turn counter clockwise to "PILOT". (FIGURE 7)
5. Depress and hold **MILLIVOLT GAS VALVE** knob until air is bled and gas flows to pilot. Press **PIEZZO IGNITOR BUTTON** (FIGURE 8) to light pilot. Continue to depress **MILLIVOLT GAS VALVE** Knob until pilot remains lit when knob is released (approximately 60 to 90 seconds).
6. If Pilot does not remain lit, repeat steps 1 through 5 and allow more time after Pilot Lighting before releasing knob.

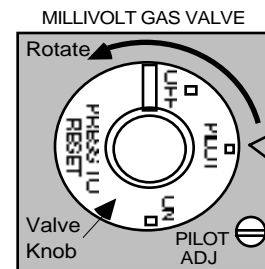

FIGURE 7

PILOT FLAME ADJUSTMENT (TR-18; 24; 30-S-(SWITCH PILOT CONTROL):

PILOT ADJUSTMENT:

1. Pilot flame should be steady and soft blue surrounding approximately 1/2 inch of the thermocouple tip. (FIGURE 8)
2. If adjustment is necessary, use a narrow long stem screw driver to turn the **PILOT ADJUST SCREW**.

PILOT ADJUST SCREW. (FIGURE 8) Turn clockwise for less flame, counter clockwise for more flame.

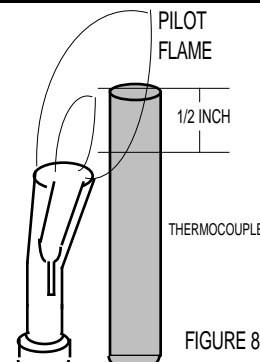

FIGURE 8

BURNER OPERATION (SWITCH PILOT CONTROL IN MANUAL MODE):

1. Turn **MILLIVOLT GAS VALVE** Knob to "ON" (FIGURE 7).
2. To turn burner on, place the **CONTROL SELECTOR SWITCH** in the "ON" position. (FIGURE 9).
3. To turn only the burners off (pilot remains lit), place the **CONTROL SELECTOR SWITCH** in the "OFF" position.

NOTE: All three burner's (**FRONT BURNER**, **MIDDLE BURNER** and **REAR BURNER**) flame height are directly controlled by the position of the **MILLIVOLT GAS VALVE** Knob (FIGURE 7).

4. **Complete Shutdown (Including Pilot):** Place **Control Selector Switch** in "OFF". Turn "OFF" all **Accessory Switches**. Slightly push and turn **MILLIVOLT GAS VALVE** Knob to "OFF".

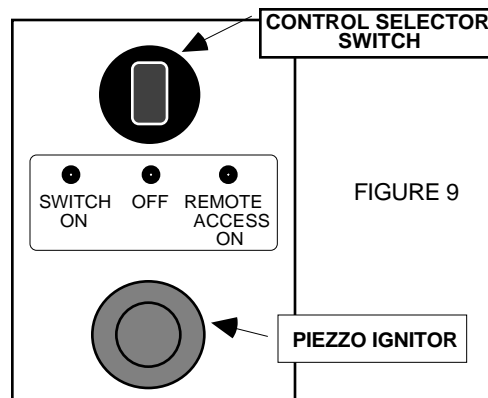
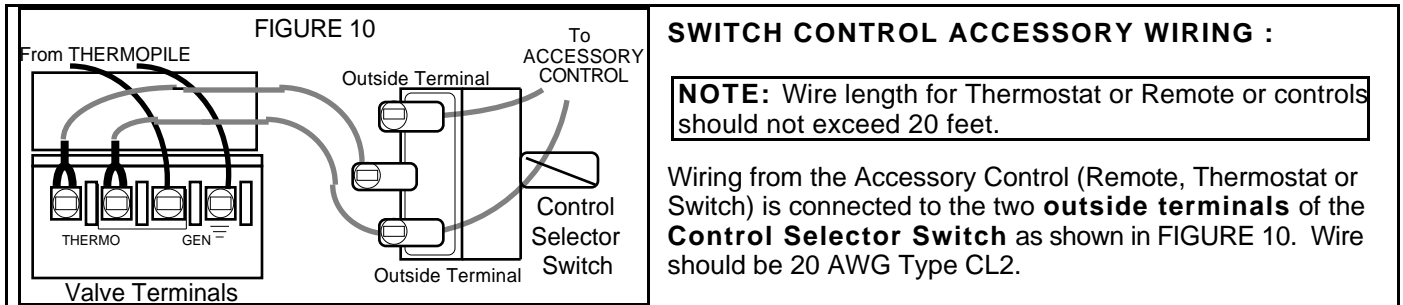

FIGURE 9

BURNER OPERATION (SWITCH PILOT CONTROL IN ACCESSORY MODE):

1. Place **Control Selector Switch** in the "REMOTE ACCESS ON" position. Burner "ON" or "OFF" is now controlled by the position of the accessory control being used with the burner. Individual operating instructions for each Accessory Option are included with the individual accessory.
2. **Complete Shutdown (Including Pilot):** Place **Control Selector Switch** in "OFF". Turn "OFF" all **Accessory Switches**. Slightly push and turn **MILLIVOLT GAS VALVE (Figure 7) Knob** to "OFF".



SWITCH CONTROL ACCESSORY OPTIONS:

- Ultra-Sonic Wireless Remote (Model "F10-AB")
- Infrared Wireless Remote With Thermostat (Model "IRRC")
- Wall Switch (Model "WS-1")
- Wall Thermostat (Model "TS-1")
- Wall Timer (60 Minute Timer) (Model "WT-1")
- Crackler Sound Generator option for F10 AB or IRRC (Model "CF5")

Accessory **REMOTE LOG HOUSE (Model "RH")** is available for use as a heat resistant "log" in which the receiver portion of Wireless remote option F10 AB or IRRC may be located.

Accessory **CRACKLER LOG HOUSE (Model "CH")** is available for use as a heat resistant "log" in which the **CRACKLER** Sound Generator option for both the F10 AB and IRRC wireless remotes may be located.

REAR BURNER ADJUSTMENT (TOP BURNER CONTROL VALVE):

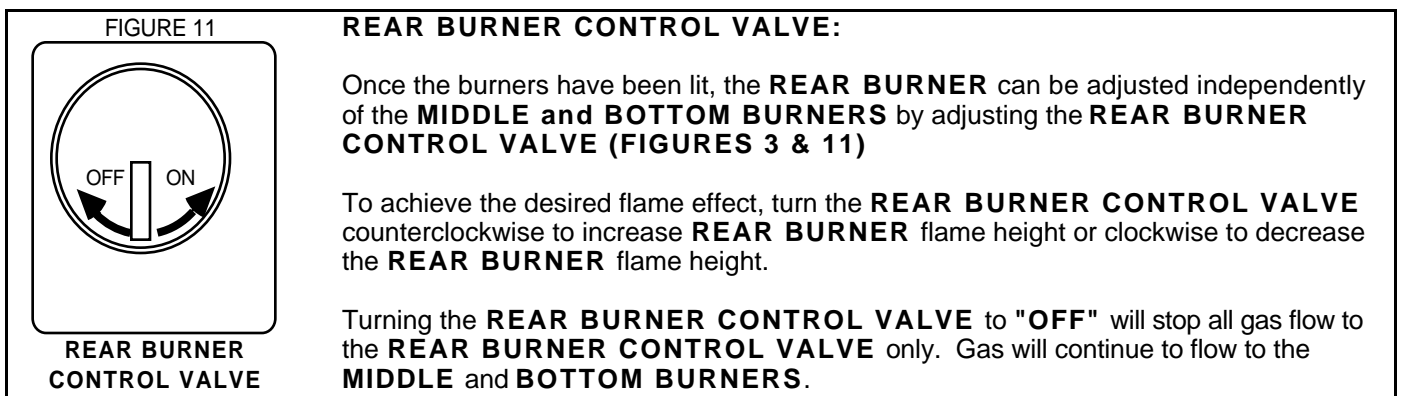

MAINTENANCE and CUSTOMER RESPONSIBILITIES:

Very little maintenance is required. The carbon build-up that results from the gas flame is natural and adds to the realistic appearance of the set. If carbon becomes excessive it can be lightly brushed or vacuumed away. If desired, the logs may be removed from the firebox and gently sprayed clean with water. Discoloration from heat is normal.

Periodically check the pilot burner and main burner flames. The pilot burner should be free of lint and dirt for best performance. Periodically use a brush with stiff bristles to clean pilot. The main burner should produce a relatively even flame from side to side. If not, the sand-granules may have become packed and can be loosened by working a wire or knife blade under the sand or by refilling the pan as described in the section on

ASSEMBLY AND INSTALLATION. Keep area around log set free and clear from debris.

IMPORTANT. From time to time, examine and clean the venting system. Once a year, a qualified agency must examine and clean the venting system of the solid-fuel burning fireplace.

HOW TO ORDER PARTS:

You can order parts through the supplier from whom you purchased your log set. When ordering parts, always specify the following:

FROM INFORMATION AVAILABLE ON NAME PLATE ATTACHED TO GRATE:

1. Model Number Of The Log Set 2. Serial Number Of The Log Set 3. Type Of Gas (Natural Or L.P. Gas)

FROM PARTS LIST ON PAGE FIVE: The Name Of The Part And Part Number.

MFR BY: RASMUSSEN IRON WORKS, INC. 12028 E. Philadelphia Street Whittier, California 90601

SAVE THESE INSTRUCTIONS. FILL IN BLANKS BELOW FOR YOUR PERMANENT RECORD.

CONSUMER RECORD CARD

DATE PURCHASED: _____ MODEL NO. _____
 DATE INSTALLED: _____ SERIAL NO. _____
 INSTALLED BY: _____ GAS TYPE: _____
 DEALER: _____

PARTS LIST

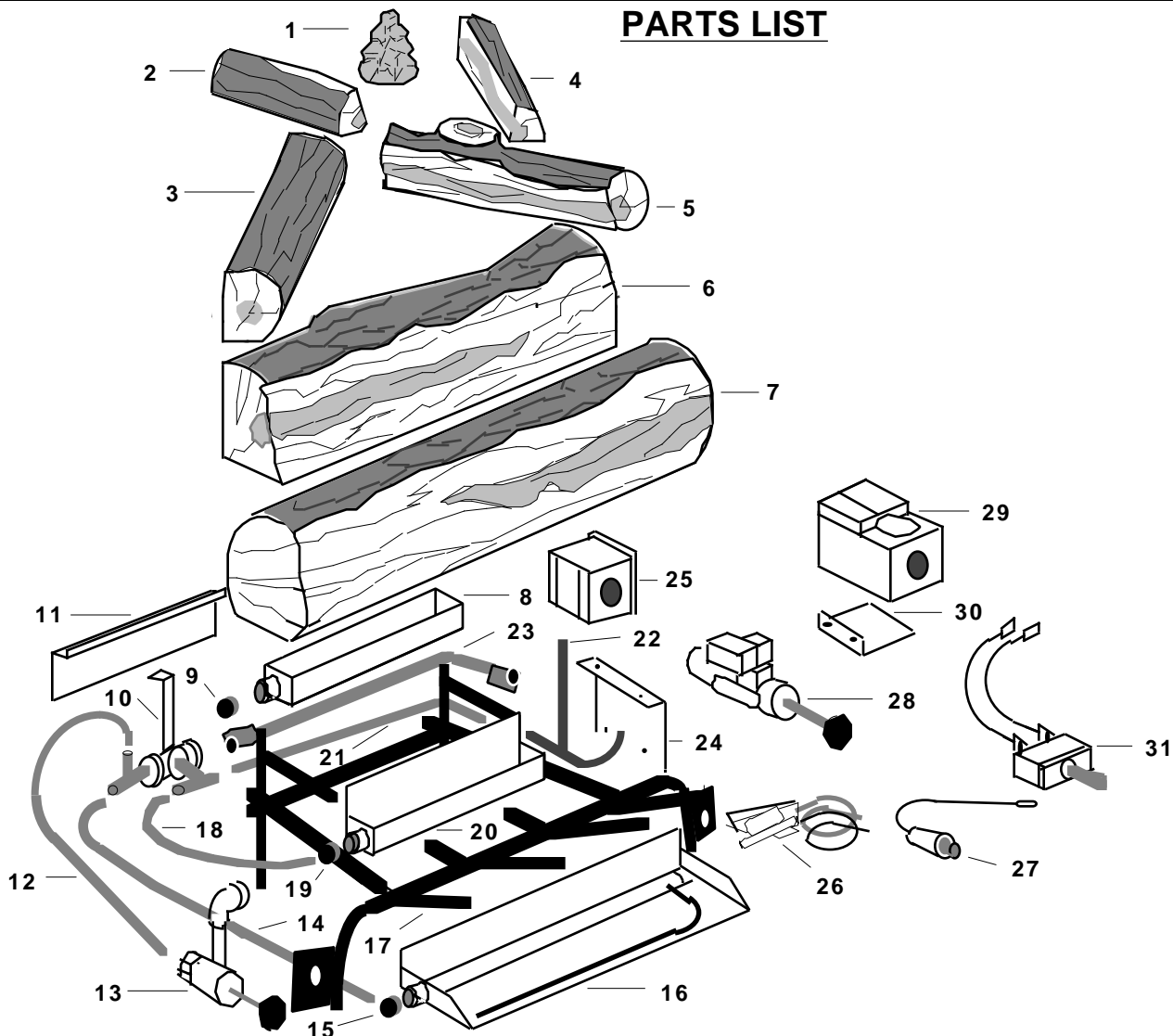

- | | | | |
|---------------------------|--|---------------------------------------|------------------------------|
| 1. Pine Cone | 10. Gas Distribution Assembly | 17. Grate | 23. Primary Connector Tubing |
| 2. Top Log Small (Left) | 11. Rear Cover Plate | 18. Middle Burner Manifold Tubing | 24. Control Mounting Plate |
| 3. Top Log Large (left) | 12. Top Burner Control Valve Manifold Tubing | 19. Middle Burner Orifice | 25. Gas Regulator Assembly |
| 4. Top Log Small (Right) | 13. Top Burner Control Valve | 20. Middle Burner (specify Nat or LP) | 26. Pilot Assembly |
| 5. Top Log (large (Right) | 14. Front Burner Manifold Tubing | 21. Lighter Tube Connector Tubing | 27. Piezzo Ignitor Assembly |
| 6.. Rear Log | 15. Front Burner Orifice | 22. Lighter Tube | 28. Manual Valve Assembly |
| 7. Front Log | | | 29. Switch Valve Assembly |
| 8. Rear Burner | | | 30. Switch Valve Mount Plate |
| 9. Rear Burner Orifice | | | 31. Switch Assembly |

LIMITED LIFETIME CONSUMER PRODUCT WARRANTY

The following warranty has been drafted to comply with the MAGNUSON-MOSS WARRANTY ACT applicable to products manufactured after July 4, 1975.

It replaces and supersedes any warranty in this package or in any printed literature.

LIMITED WARRANTY:

RASMUSSEN IRON WORKS INC, 12028 E. Philadelphia Street, Whittier California, U.S.A., Warrants this Gas Log Set and accessories against defects in materials and workmanship, and suitable for a particular purpose, for a period of:

(1) LOG CASTING - All logs are guaranteed against burnout in the original installation for the lifetime of the initial purchaser.

(2) BURNERS/GRATES - 2 years from date of purchase.

(3) SAFETY CONTROLS - Pilots and safety controls are covered by warranty of the original manufacturer only.

THIS WARRANTY IS FOR THE BENEFIT OF THE ORIGINAL PURCHASER.

WARRANTY ADJUSTMENT:

(1) RASMUSSEN agrees to repair or furnish a replacement for, but not remove or install any product or component which proves defective within the above warranty and appropriate time periods stated.

(2) BUYER shall notify RASMUSSEN of any defect within this warranty no later than thirty (30) days after a defect is discovered.

(3) No product will be accepted for return or replacement without written authorization of RASMUSSEN. Before returning merchandise, write to RASMUSSEN giving full details of the complaint and a copy of sales receipt or other evidence of purchase date. Merchandise returned without proof of purchase date will be serviced out-of-warranty at our prevailing service and parts rates. If merchandise was damaged in transit, file claim immediately with the carrier. Products returned must be addressed as follows:

RASMUSSEN IRON WORKS INC
12028 E. PHILADELPHIA STREET
WHITTIER CALIFORNIA 90601

Shipping charges must be pre-paid by the buyer.

REPAIR OR REPLACEMENT UNDER THIS WARRANTY WILL BE SHIPPED FREIGHT COLLECT.

EXCLUSIONS FROM WARRANTY:

(1) The foregoing warranty is limited solely as set forth herein and applies only for the periods designated above.

(2) RASMUSSEN shall not be liable for any loss, damage, incidental or consequential damages of any kind, whether based upon warranty, contract, or negligence, arising in connection with the sale, use, or repair of the product. Some states do not allow the exclusion or limitation of incidental or consequential damages, so the above limitation or exclusion may not apply to you.

(3) The maximum liability of RASMUSSEN in connection with this limited warranty shall not in any case exceed the contract price paid for the product claimed to be defective or unsuitable.

(4) This warranty does not extend to any product manufactured by RASMUSSEN which has been subjected to misuse, neglect, accident, improper installation, or use in violation of instructions furnished by RASMUSSEN.

(5) This warranty does not extend to or apply to any unit which has been repaired or altered at any place other than RASMUSSEN IRON WORKS INC factory, or by persons not expressly approved by RASMUSSEN.

(6) Components manufactured by any supplier other than RASMUSSEN shall bear only that warranty made by the manufacturer of that product.

(7) Freight damage, cracking from thermal shock, and color changes occur from causes beyond manufacturer's control and are not covered by any warranty.

THIS WARRANTY GIVES YOU SPECIFIC LEGAL RIGHTS, AND YOU MAY ALSO HAVE OTHER RIGHTS WHICH VARY FROM STATE TO STATE.

RASMUSSEN IRON WORKS, INC. shall be held harmless from any and all claims by the buyer as a result of injury or damage to an ultimate user or other person caused by the product sold herein by the seller to the buyer, whether the injury or damage results from the assembly, installation, operation, shipment, storage or manufacture of this product. RASMUSSEN IRON WORKS, INC. makes no warranties, expressed or implied, other than those expressly stated herein.

- CUSTOMER RESPONSIBILITY -

Your Gas Log is designed to burn with a natural smoky yellow flame that produces carbon soot. Like a wood fire, burning a Gas Log with the flue blocked or closed will cause fumes and smoke to remain in the room and cause health hazards. **DAMPER MUST BE FULLY OPEN WHEN BURNING A GAS LOG SET.** Never burn wood with your gas log set as this will reduce the life of your gas Log Set and will void any warranty.